

# JVC KD-R208

## CD RECEIVER: INSTRUCTIONS/INSTALLATION

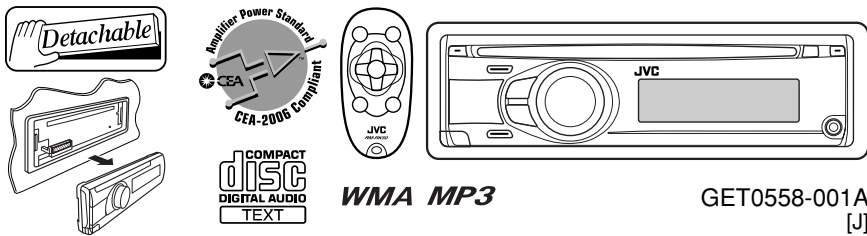

**Thank you for purchasing a JVC product.**

Please read all instructions carefully before operation, to ensure your complete understanding and to obtain the best possible performance from the unit.

Installation/connection are explained at the last section of this manual (reverse page, indicated with symbol).

### For customer Use:

Enter below the Model No. and Serial No. which are located on the top or bottom of the cabinet. Retain this information for future reference.

Model No. \_\_\_\_\_

Serial No. \_\_\_\_\_

0808DTSMDTJEIN

EN

© 2008 Victor Company of Japan, Limited

## ENGLISH

### INFORMATION (For U.S.A.)

This equipment has been tested and found to comply with the limits for a Class B digital device, pursuant to Part 15 of the FCC Rules. These limits are designed to provide reasonable protection against harmful interference in a residential installation. This equipment generates, uses, and can radiate radio frequency energy and, if not installed and used in accordance with the instructions, may cause harmful interference to radio communications. However, there is no guarantee that interference will not occur in a particular installation. If this equipment does cause harmful interference to radio or television reception, which can be determined by turning the equipment off and on, the user is encouraged to try to correct the interference by one or more of the following measures:

- Reorient or relocate the receiving antenna.
- Increase the separation between the equipment and receiver.
- Connect the equipment into an outlet on a circuit different from that to which the receiver is connected.
- Consult the dealer or an experienced radio/TV technician for help.

### Caution

Changes or modifications not approved by JVC could void the user's authority to operate the equipment.

### IMPORTANT FOR LASER PRODUCTS

1. CLASS 1 LASER PRODUCT
2. CAUTION: Do not open the top cover. There are no user serviceable parts inside the unit; leave all servicing to qualified service personnel.
3. CAUTION: (For U.S.A.) Visible and/or invisible class II laser radiation when open. Do not stare into beam. (For Canada) Visible and/or invisible class 1M laser radiation when open. Do not view directly with optical instruments.
4. REPRODUCTION OF LABEL: CAUTION LABEL, PLACED OUTSIDE THE UNIT.

<b>CAUTION</b> VISIBLE AND/OR INVISIBLE CLASS II LASER RADIATION WHEN OPEN. DO NOT VIEW DIRECTLY WITH OPTICAL INSTRUMENTS. IEC00025-1:2001 (ENX)	<b>ATTENTION</b> RAYONNEMENT LASER VISIBLE ET/OU INVISIBLE DE CLASSE II LORSQU'ON OUVRE LE CAS. NE PAS REGARDER DIRECTEMENT AVEC DES INSTRUMENTS OPTIQUES. (FRA)	<b>AVISO</b> RADIACION LASER DE CLASE II VISIBLE Y/O INVISIBLE CUANDO ESTA ABIERTO. NO MIRAR DIRECTAMENTE CON INSTRUMENTAL OPTICA. (ESP)	<b>VARNING</b> SYNLIG OCH/ELLER OSYNLIG LASERSTRÅLNING, KLASS II, NÅR DENNÅ LÄSAR ÖPPNAD. BETRAKTA EJ STRÅLEN MED OPTISKA INSTRUMENT. (SWE)	<b>注意</b> この装置は、目視 及び非目視の可視 のクラスIIレーザー 放射が 出す。光学機器で 見ないでください。 (JPN)	<b>CAUTION</b> VISIBLE AND/OR INVISIBLE CLASS II LASER RADIATION WHEN OPEN. DO NOT STARE INTO BEAM. FDA 21 CFR (ENX)
--	--	--	--	--	--



[European Union only]

### For safety...

- Do not raise the volume level too much, as this will block outside sounds, making driving dangerous.
- Stop the car before performing any complicated operations.

### Temperature inside the car...

If you have parked the car for a long time in hot or cold weather, wait until the temperature in the car becomes normal before operating the unit.

### Warning

If you need to operate the unit while driving, be sure to look around carefully or you may be involved in a traffic accident.

### Caution on volume setting

Discs produce very little noise compared with other sources. Lower the volume before playing a disc to avoid damaging the speakers by the sudden increase of the output level.

## MORE ABOUT THIS UNIT

### Basic operations

- By pressing SRC on the unit, you can also turn on the power. If the source is ready, playback also starts.
- If you turn off the power while listening to a disc, disc play will start from where it had been stopped previously next time you turn on the power.
- If no operation is done for about 30 seconds after pressing MENU button, the operation will be canceled.

### Tuner operations

- During SSM search...
  - All previously stored stations are erased and the stations are stored anew.
  - When SSM is over, the station stored in the lowest preset number will be automatically tuned in.

### Disc operations

#### Caution for DualDisc playback

- The Non-DVD side of a "DualDisc" does not comply with the "Compact Disc Digital Audio" standard. Therefore, the use of Non-DVD side of a DualDisc on this product may not be recommended.

### General

- This unit has been designed to reproduce CDs/CD Texts, and CD-Rs (Recordable)/CD-RWs (Rewritable) in audio CD (CD-DA) and MP3/WMA formats.

### Playing a CD-R or CD-RW

- Use only "finalized" CD-Rs or CD-RWs.
- This unit can play back multi-session discs; however, unclosed sessions will be skipped while playing.
- Some CD-Rs or CD-RWs may not be played back on this unit:
  - Discs are dirty or scratched.
  - Moisture condensation has occurred on the lens inside the unit.
  - The pickup lens inside the unit is dirty.
  - The files on the CD-R/CD-RW are written using the "Packet Write" method.
  - There are improper recording conditions (missing data, etc.) or media conditions (stained, scratched, warped, etc.).
- CD-RWs may require a longer readout time since the reflectance of CD-RWs is lower than that of regular CDs.

### Playing an MP3/WMA disc

- This unit can play back MP3/WMA files with the extension code <.mp3> or <.wma> (regardless of the letter case—upper/lower).
- This unit can show the names of albums, artists (performer), and tag (Version 1.0, 1.1, 2.2, 2.3, or 2.4) for MP3 files and for WMA files
- This unit can display only one-byte characters. No other characters can be correctly displayed.
- This unit can play back MP3/WMA files meeting the conditions below:
  - Bit rate: 8 kbps — 320 kbps
  - Sampling frequency: 48 kHz, 44.1 kHz, 32 kHz (for MPEG-1) 24 kHz, 22.05 kHz, 16 kHz (for MPEG-2)
  - Disc format: ISO 9660 Level 1/ Level 2, Romeo, Joliet, Windows long file name
- The maximum number of characters for file/folder names vary depending on the disc format used (includes 4 extension characters—<.mp3> or <.wma>).
  - ISO 9660 Level 1: up to 12 characters; ISO 9660 Level 2: up to 31 characters; Romeo: up to 128 characters; Joliet: up to 64 characters; Windows long file name: up to 128 characters
- This unit can recognize a total of 512 files, 255 folders, and 8 hierarchical levels.
- This unit can play back files recorded in VBR (variable bit rate). Files recorded in VBR have a discrepancy in the elapsed time display, and do not show the actual elapsed time. In particular, this difference becomes noticeable after performing the search function.
- This unit cannot play back the following files:
  - MP3 files encoded in: MP3i and MP3 PRO format, in an inappropriate format, layer 1/2.
  - WMA files: encoded in lossless, professional, and voice format; not based upon Windows Media® Audio; copy-protected with DRM.
  - Files which have data such as WAVE, ATRAC3, etc.
- The search function works but search speed is not constant.

### Title assignment

- If you try to assign titles to more than 30 station frequencies, "NAME FULL" appears. Delete unwanted titles before assignment.

## MAINTENANCE

### How to clean the connectors

Wipe the connectors with a cotton swab or cloth moistened with alcohol.

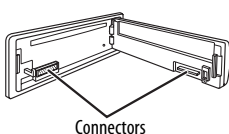

Connectors

### To keep discs clean

Wipe in a straight line from center of disc to edge. Do not use liquid cleaners, thinners, or benzene.



### To play new discs

Remove any rough areas from the inner and outer edges of the disc.



### Moisture condensation

Moisture may condense on the lens inside the unit. Eject the disc and leave the unit turned on for a few hours until the moisture has evaporated.

### Do not use the following discs:

Single CD—8 cm (3-3/16") disc



Warped disc



Sticker and sticker residue



Stick-on label



Unusual shape



C-thru Disc (semi-transparent disc)



Transparent or semi-transparent parts on its recording area



## PREPARATIONS

### How to reset your unit

Reset the unit after installation is complete.

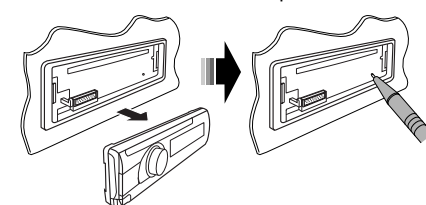

- Your preset adjustments will also be erased.

### How to forcibly eject a disc

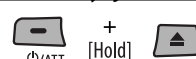

- Be careful not to drop the disc when it ejects.
- If this does not work, reset your unit.

### Basic settings

**1 Enter Menu operation.**

 [Hold]

**2 Select an item.**

 [Turn] → [Press]

**1 Cancel the display demonstrations**  
Select "DEMO," then "DEMO OFF."

**2 Set the clock**  
Select "CLOCK" → "CLOCK SET."  
Adjust the hour, then press control dial once to proceed to adjust the minute.

- To return to the previous menu, press BACK.

Basic operations

Control panel

- Turn on the power.
- Attenuate the sound (if the power is on).
- Turn off the power [Hold].

Select the source.  
FM → AM\*1 → CD\*2 → AUX IN\*1

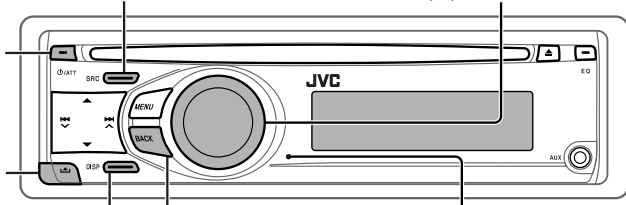

- Control the volume or selection [Turn].
- Confirm the selection [Press].
- **FM**: Enter SSM preset mode [Hold].
- **CD**: Enter playback mode [Hold].

Detach the panel.

Check the current clock time/other information. See also "CLOCK DISP" of "Menu operations."  
Return to the previous menu.  
Remote sensor  
DO NOT expose to strong light.

\*1 You cannot select these sources if they were disabled in the Menu (See "Menu operations").  
\*2 You cannot select "CD" as the playback source if no disc is in the unit.

Display window

- Source display
- Track number
- Folder number
- Time countdown indicator

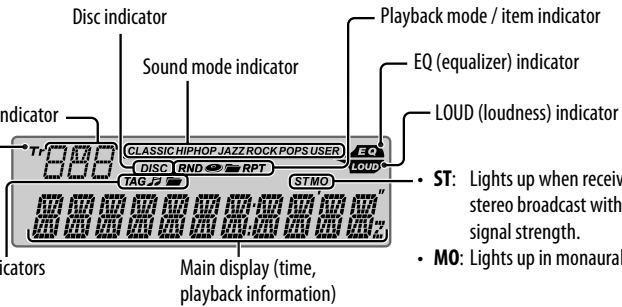

- **ST**: Lights up when receiving an FM stereo broadcast with sufficient signal strength.
- **MO**: Lights up in monaural mode.

Disc information indicators  
Main display (time, playback information)

Remote controller—RM-RK50

Installing battery

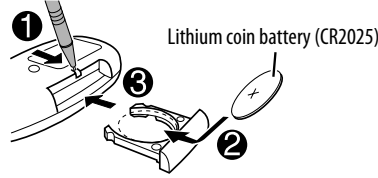

- Warning: To prevent accidents and damage**
- Do not install any battery other than CR2025 or its equivalent.
  - Store out of reach of children.
  - Do not recharge, short, or dismantle.
  - Do not dispose of in fire.
  - Do not carry around with other metallic materials.

Caution:

- Danger of explosion if battery is incorrectly replaced. Replace only with the same or equivalent type.
- Battery shall not be exposed to excessive heat such as sunshine, fire, or the like.

If the effectiveness of the remote controller decreases, replace the battery.

For USA-California Only: This product contains a CR Coin Cell Lithium Battery which contains Perchlorate Material—special handling may apply. See [www.dtsc.ca.gov/hazardouswaste/perchlorate](http://www.dtsc.ca.gov/hazardouswaste/perchlorate)

Features

- Turns the power on if pressed briefly or attenuates the sound when power is on.
- Turns the power off if pressed and held.
- Changes the preset stations.
- Changes the folders of MP3/WMA discs.
- Selects the sound mode (iEQ: intelligent equalizer).
- Selects the source.
- Searches for stations if pressed briefly.
- Fast-forwards or reverses the track if pressed and held.
- Changes the track of the disc if pressed briefly.
- Adjusts the volume level.

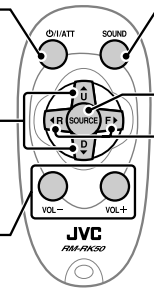

Radio operations

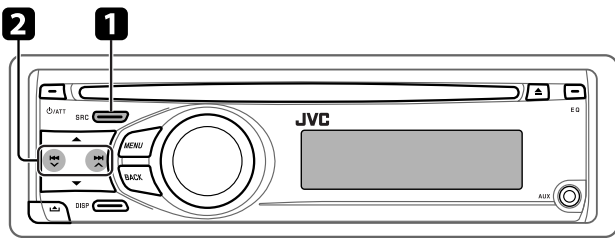

1 Select "FM" or "AM."

2 Search for a station—Auto Search.

Manual Search: Hold either one of the buttons until "M" flashes on the display, then press it repeatedly.

When an FM stereo broadcast is hard to receive

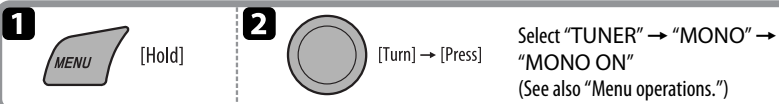

Reception improves, but the stereo effect will be lost. (MO indicator lights up.)  
To restore the stereo effect, repeat the same procedure to select "MONO OFF." The MO indicator goes off.

FM station automatic presetting—SSM (Strong-station Sequential Memory)

You can preset up to 18 stations for FM.

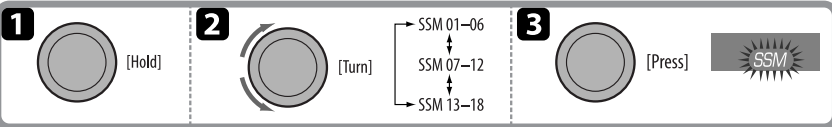

To preset other 6 stations, repeat from step 1 again.

Manual presetting (FM/AM)

You can preset up to 18 stations for FM and 6 stations for AM.  
Example: Storing the FM station of 92.50 MHz into preset number "P04".

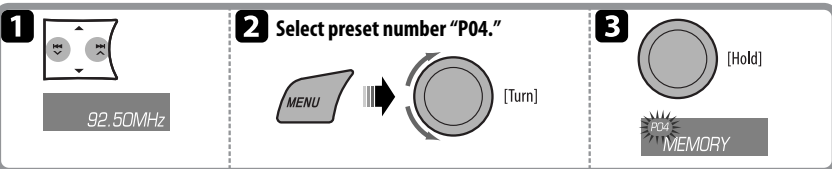

Selecting preset station

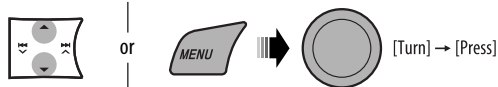

Disc operations

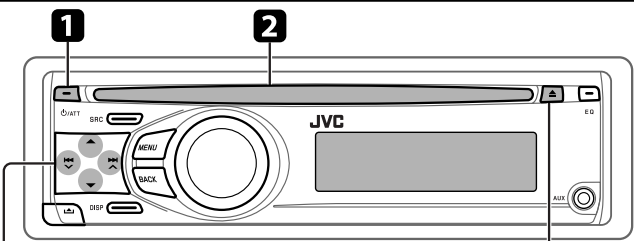

- [Left/Right] Go to the previous or next track.
- [Hold] Reverse or fast-forward the track.
- [Up/Down] Go to the previous or next folder (for MP3/WMA discs).
- Eject disc.
- "NO DISC" appears.
- Press SRC to listen to another playback source.

1 Turn on the power.

2 Insert disc.

All tracks will be played repeatedly until you change the source or eject the disc.

Selecting the playback modes

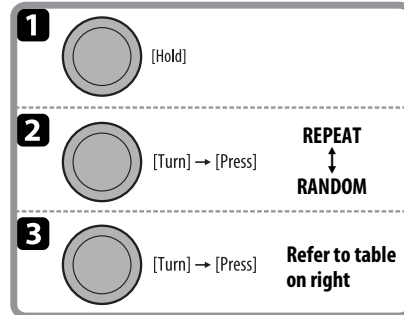

REPEAT	TRACK RPT	: Repeats current track
	FOLDER RPT	: MP3/WMA: Repeats current folder
RANDOM	FOLDER RND	: MP3/WMA: Randomly plays all tracks of current folder, then tracks of next folders
	ALL RND	: Randomly plays all tracks

- To cancel repeat play or random play, select "RPT OFF" or "RND OFF."
- To return to the previous menu, press BACK.

Changing the display information

While playing an audio CD or CD Text	While playing an MP3 or a WMA disc
(A) → (B) → Disc title/performer*1 → Track title*1 → (back to the beginning)	(A) → (B) → Album name/performer (folder name*2) → Track title (file name*2) → (back to the beginning)

- (A) : The elapsed playing time with the current track number
- (B) : Clock with the current track number

\*1 If the current disc is an audio CD, "NO NAME" appears.  
\*2 If an MP3/WMA file does not have tags or "TAG DISPLAY" is set to "TAG OFF," folder name and file name appear.

Prohibiting disc ejection

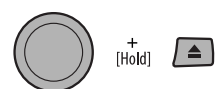

To cancel the prohibition, repeat the same procedure.

Selecting a track/folder

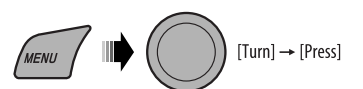

- For MP3/WMA disc, select the desired folder, then the desired track by performing the control dial.
- To return to the previous menu, press BACK.

External component operations

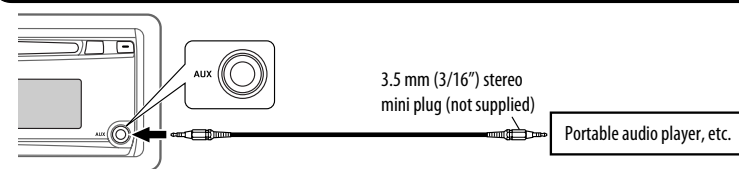

You can connect an external component to the AUX (auxiliary) input jack on the control panel.

- Make sure "AUX ON" is selected in the "SRC SELECT" → "AUX IN" setting, see "Menu operations."



# SETTINGS

## Sound adjustments

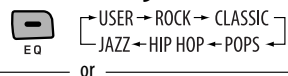

**1** [MENU] [Hold]

**2** [Turn] → [Press] Select "EQ"

→ USER\* → ROCK → CLASSIC  
← JAZZ ← HIP HOP ← POPS ←

Indication (For)	Preset values		
	BASS	TREBLE	LOUD
<b>USER</b> (Flat sound)	00	00	OFF
<b>ROCK</b> (Rock or disco music)	+03	+01	ON
<b>CLASSIC</b> (Classical music)	+01	-02	OFF
<b>POPS</b> (Light music)	+04	+01	OFF
<b>HIP HOP</b> (Funk or rap music)	+02	00	ON
<b>JAZZ</b> (Jazz music)	+02	+03	OFF

\* You can change "USER" settings and store as your own sound mode (see below).

## Storing your own sound mode

**1** Select "USER" for "EQ".

→ USER → ROCK → CLASSIC  
← JAZZ ← HIP HOP ← POPS ←

**2** While "USER" is shown on the display... [MENU] [Hold]

**3** [Turn] → [Press]

1 Select a tone.  
**BASS** ↔ **TREBLE**

2 Adjust the Level.  
**-06 to +06**

3 Repeat 1 and 2 for the other tone if necessary.

This mode will be canceled if no operation is done for about 30 seconds.

## Title assignment

You can assign titles to 30 station frequencies (FM and AM) using 8 characters (maximum) for each title.

**1** Select "FM" or "AM." SRC [Turn]

**2** Show the title entry screen. DISP [Hold]

**3** Select a character. [Turn]

A	B	C	D	E	F	G
H	I	J	K	L	M	N
O	P	Q	R	S	T	U
V	W	X	Y	Z	0	1
2	3	4	5	6	7	8
9	-	/	<	>	SPACE	

**4** Move to the next (or previous) character position. [Left/Right]

Repeat steps 1 and 2 until you finish entering the title.

**5** Finish the procedure. [Press]

## To erase the entire title

In step 2 above... DISP [Hold] [Right] [Press]

## Menu operations

**1** [MENU] [Hold]

**2** [Turn] → [Press]

**3** Repeat step 2 if necessary.  
• To return to the previous menu, press BACK.

	Menu items	Selectable settings	Initial: <u>Underlined</u>
DEMO	<b>DEMO</b>	• <b>DEMO ON</b> : The display demonstration will be activated automatically if no operation is done for about 20 seconds. • <b>DEMO OFF</b> : Cancels.	
	<b>CLOCK DISP</b> *1	• <b>CLOCK ON</b> : The clock time is shown on the display at all times when the power is turned off. • <b>CLOCK OFF</b> : Cancels; pressing DISP will show the clock time for about 5 seconds when the power is turned off.	
CLOCK	<b>CLOCK SET</b>	: Adjust the hour, then the minute. [Initial: 1:00]	
	<b>EQ</b>	: Select a preset sound mode suitable to the music genre. <b>USER, ROCK, CLASSIC, POPS, HIP HOP, JAZZ</b>	
DISPLAY	<b>DIMMER</b>	• <b>DIMMER ON</b> : Dims the display and button illumination. • <b>DIMMER OFF</b> : Cancels.	
	<b>SCROLL</b> *2	• <b>SCROLL ONCE</b> : Scrolls the displayed information once. • <b>SCROLL AUTO</b> : Repeats scrolling (at 5-second intervals). • <b>SCROLL OFF</b> : Cancels. Pressing DISP for more than one second can scroll the display regardless of the setting.	
	<b>TAG DISPLAY</b>	• <b>TAG ON</b> : Shows the Tag information while playing MP3/WMA tracks. • <b>TAG OFF</b> : Cancels.	
	<b>AREA</b>	• <b>AREA US</b> : When using in North/Central/South America. AM/FM intervals are set to 10 kHz/200 kHz. • <b>AREA EU</b> : When using in any other areas. AM/FM intervals are set to 9 kHz/50 kHz (100 kHz during auto search). • <b>AREA SA</b> : When using in South American countries where FM interval is 100 kHz. AM interval is set to 10 kHz.	
TUNER	<b>MONO</b> *3	• <b>MONO ON</b> : Activate monaural mode to improve FM reception, but stereo effect will be lost. • <b>MONO OFF</b> : Restore the stereo effect.	
	<b>IF BAND</b>	• <b>AUTO</b> : Increases the tuner selectivity to reduce interference noises between adjacent stations. (Stereo effect may be lost.) • <b>WIDE</b> : Subject to interference noises from adjacent stations, but sound quality will not be degraded and the stereo effect will remain.	
	<b>FADER</b> *4	<b>R06 – F06</b> : Adjust the front and rear speaker output balance. [Initial: 00]	
AUDIO	<b>BALANCE</b>	<b>L06 – R06</b> : Adjust the left and right speaker output balance. [Initial: 00]	
	<b>LOUD</b>	• <b>LOUD OFF</b> : Cancels. • <b>LOUD ON</b> : Boost low and high frequencies to produce a well-balanced sound at a low volume level.	
	<b>AUX ADJUST</b>	<b>AUX ADJ 00 – AUX ADJ 05</b> : Adjust the auxiliary input level to avoid the sudden increase of the output level when changing the source to external component connected to the AUX input jack on the control panel.	

\*1 If the power supply is not interrupted by turning off the ignition key of your car, it is recommended to select "CLOCK OFF" to save the car's battery.

\*2 Some characters or symbols will not be shown correctly (or will be blanked) on the display.

\*3 Displayed only when the source is "FM."

\*4 If you are using a two-speaker system, set the fader level to "00."

	Menu items	Selectable settings	Initial: <u>Underlined</u>
AUDIO	<b>BEEP</b>	• <b>BEEP ON</b> : Activates the keypress tone. • <b>BEEP OFF</b> : Deactivates the keypress tone.	
	<b>AMP GAIN</b> *5	• <b>HIGH POWER</b> : VOLUME 00 – VOLUME 50 • <b>LOW POWER</b> : VOLUME 00 – VOLUME 30 (Select if the maximum power of each speaker is less than 50 W to prevent damaging the speaker.)	
SRC SELECT	<b>AM</b> *6	• <b>AM OFF</b> : Disable "AM" in source selection. • <b>AM ON</b> : Enable "AM" in source selection.	
	<b>AUX IN</b> *7	• <b>AUX OFF</b> : Disable "AUX IN" in source selection. • <b>AUX ON</b> : Enable "AUX IN" in source selection.	

\*5 The volume level automatically changes to "VOLUME 30" if you change to "LOW POWER" with the volume level is set higher than "VOLUME 30."

\*6 Displayed only when any source other than "AM" is selected.

\*7 Displayed only when any source other than "AUX IN" is selected.

## TROUBLESHOOTING

	Symptoms	Remedies/Causes
General	• Sound cannot be heard from the speakers.	• Adjust the volume to the optimum level. • Check the cords and connections.
	• This unit does not work at all. • "AUX IN" cannot be selected.	Reset the unit. Check the "SRC SELECT" → "AUX IN" setting (see "Menu operations").
FM/AM	• SSM automatic presetting does not work.	Store stations manually.
	• Static noise while listening to the radio. • "AM" cannot be selected.	Connect the antenna firmly. Check the "SRC SELECT" → "AM" setting (see "Menu operations").
Disc playback	• Disc cannot be played back. • CD-R/CD-RW cannot be played back. • Tracks on the CD-R/CD-RW cannot be skipped.	Insert the disc correctly. • Insert a finalized CD-R/CD-RW. • Finalize the CD-R/CD-RW with the component which you used for recording.
	• Disc can be neither played back nor ejected. • Disc sound is sometimes interrupted.	• Unlock the disc. • Eject the disc forcibly. • Stop playback while driving on rough roads. • Change the disc. • Check the cords and connections.
	• "NO DISC" appears on the display. • "PLEASE" and "EJECT" appear alternately on the display.	Insert a playable disc into the loading slot. Press ▲, then insert a disc correctly.
	• Disc cannot be played back.	• Use a disc with MP3/WMA tracks recorded in a format compliant with ISO 9660 Level 1, Level 2, Romeo, or Joliet. • Add the extension code <.mp3> or <.wma> to the file names.
MP3/WMA playback	• Noise is generated.	Skip to another track or change the disc. (Do not add the extension code <.mp3> or <.wma> to non-MP3 or WMA tracks.)
	• A longer readout time is required ("READING" keeps flashing on the display).	Do not use too many hierarchical levels and folders.
	• Tracks are not played back in the order you have intended.	Playback order is determined when the files are recorded.
	• The elapsed playing time is not correct.	This sometimes occurs during playback. This is caused by how the tracks are recorded on the disc.
	• The correct characters are not displayed (e.g. album name).	This unit can only display alphabets (upper case), numbers, and a limited number of symbols.

• Microsoft and Windows Media are either registered trademarks or trademarks of Microsoft Corporation in the United States and/or other countries.

## SPECIFICATIONS

### Audio amplifier section

Power Output:  
20 W RMS × 4 Channels at 4 Ω and  
≤ 1% THD+N  
Signal to Noise Ratio:  
80 dBA (reference: 1 W into 4 Ω)



Load Impedance: 4 Ω (4 Ω to 8 Ω allowance)  
Tone Control Range: Bass: ±12 dB at 100 Hz  
Treble: ±12 dB at 10 kHz  
Frequency Response: 40 Hz to 20 000 Hz  
Line-Out Level/Impedance: 2.5 V/20 kΩ load (full scale)  
Output Impedance: 1 kΩ

### Tuner section

Frequency Range:  
FM: 87.5 MHz to 107.9 MHz  
(with channel interval set to 100 kHz or 200 kHz)  
87.5 MHz to 108.0 MHz  
(with channel interval set to 50 kHz)  
AM: 530 kHz to 1 710 kHz  
(with channel interval set to 10 kHz)  
531 kHz to 1 602 kHz  
(with channel interval set to 9 kHz)

**[FM Tuner]**  
Usable Sensitivity: 11.3 dBf (1.0 μV/75 Ω)  
50 dB Quieting Sensitivity: 16.3 dBf (1.8 μV/75 Ω)  
Alternate Channel Selectivity (400 kHz): 65 dB  
Frequency Response: 40 Hz to 15 000 Hz  
Stereo Separation: 35 dB

**[AM Tuner]**  
Sensitivity/Selectivity: 20 μV/35 dB

If a kit is necessary for your car, consult your telephone directory for the nearest car audio speciality shop.

### CD player section

Type: Compact disc player  
Signal Detection System: Non-contact optical pickup (semiconductor laser)  
Number of channels: 2 channels (stereo)  
Frequency Response: 5 Hz to 20 000 Hz  
Dynamic Range: 93 dB  
Signal-to-Noise Ratio: 98 dB  
Wow and Flutter: Less than measurable limit  
MP3 Decoding Format: MPEG1/2 Audio Layer 3  
Max. Bit Rate: 320 kbps  
WMA (Windows Media® Audio) Decoding Format: Max. Bit Rate: 192 kbps

### General

Power Requirement: Operating Voltage: DC 14.4 V  
(11 V to 16 V allowance)  
Grounding System: Negative ground  
Allowable Operating Temperature: 0°C to +40°C (32°F to 104°F)  
Dimensions (W × H × D):  
Installation Size (approx.):  
182 mm × 52 mm × 160 mm  
(7-3/16" × 2-1/16" × 6-5/16")  
Panel Size (approx.):  
188 mm × 58 mm × 6 mm  
(7-7/16" × 2-5/16" × 1/4")  
Mass (approx.):  
1.3 kg (2.9 lbs) (excluding accessories)

Design and specifications are subject to change without notice.

**Having TROUBLE with operation?**  
**Please reset your unit**  
**Still having trouble??**  
**Call 1-800-252-5722 (USA ONLY)**  
**http://www.jvc.com**



## PREPARATION

This unit is designed to operate on **12 V DC, NEGATIVE ground electrical systems**. If your vehicle does not have this system, a voltage inverter is required, which can be purchased at JVC car audio dealers.

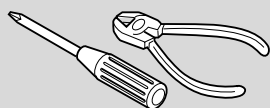

## WARNINGS

To prevent short circuits, we recommend that you disconnect the battery's negative terminal and make all electrical connections before installing the unit.

- **Be sure to ground this unit to the car's chassis again after installation.**

### Notes:

- Replace the fuse with one of the specified rating. If the fuse blows frequently, consult your JVC car audio dealer.
- It is recommended to connect to the speakers with maximum power of more than 50 W (both at the rear and at the front, with an impedance of 4 Ω to 8 Ω). If the maximum power is less than 50 W, change "AMP GAIN" setting to prevent the speakers from being damaged (see "Menu operations").
- To prevent short-circuit, cover the terminals of the UNUSED leads with insulating tape.
- The heat sink becomes very hot after use. Be careful not to touch it when removing this unit.

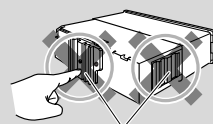

Heat sink

## TROUBLESHOOTING

- **The fuse blows.**
  - \* Are the red and black leads connected correctly?
- **Power cannot be turned on.**
  - \* Is the yellow lead connected?
- **No sound from the speakers.**
  - \* Is the speaker output lead short-circuited?
- **Sound is distorted.**
  - \* Is the speaker output lead grounded?
  - \* Are the "-" terminals of L and R speakers grounded in common?
- **Noise interfere with sounds.**
  - \* Is the rear ground terminal connected to the car's chassis using shorter and thicker cords?
- **This unit becomes hot.**
  - \* Is the speaker output lead grounded?
  - \* Are the "-" terminals of L and R speakers grounded in common?
- **This unit does not work at all.**
  - \* Have you reset your unit?

### Parts list for installation and connection

A Control panel	1	E Washer (ø5)	1	I Handles	2
B Sleeve	1	F Lock nut (M5)	1	J Remote controller	1
C Trim plate	1	G Mounting bolt—M4 x 5 mm (M4 x 1/4"); M5 x 12.5 mm (M5 x 1/2")	1	K Battery	1
D Power cord	1	H Rubber cushion	1		

## INSTALLATION

The following illustration shows a typical installation. If you have any questions or require information regarding installation kits, consult your JVC car audio dealer or a company supplying kits.

- If you are not sure how to install this unit correctly, have it installed by a qualified technician.

### In dash-mounting

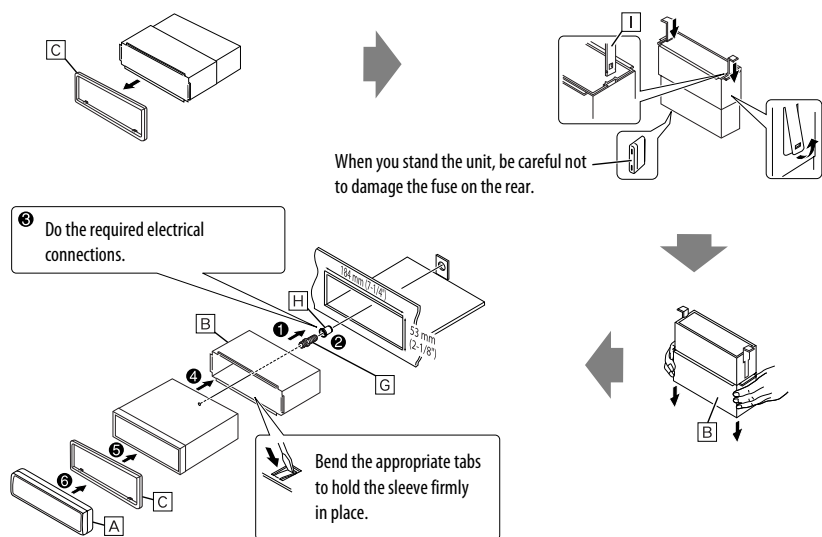

### Removing the unit

Before removing the unit, release the rear section.

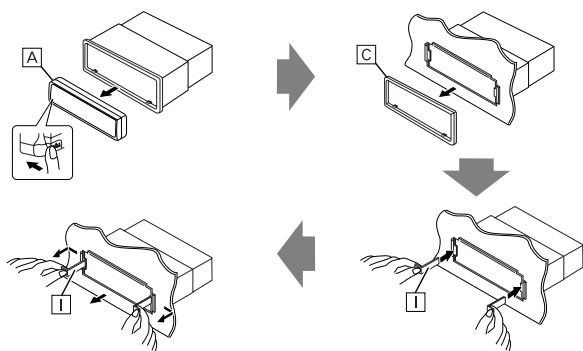

### When using the optional stay

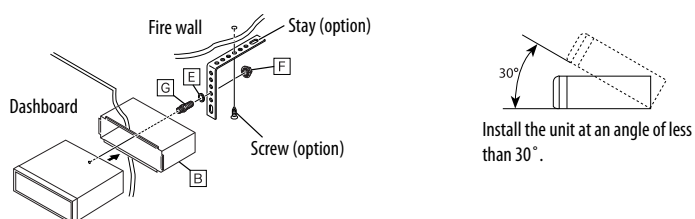

### When installing the unit without using the sleeve

In a Toyota car for example, first remove the car radio and install the unit in its place.

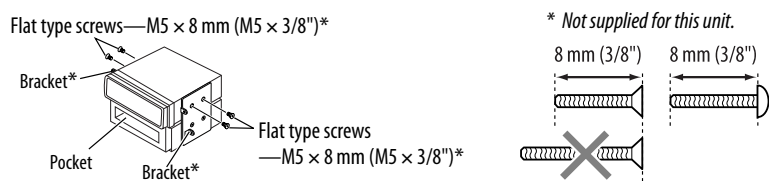

## ELECTRICAL CONNECTIONS

### Typical connections

**Before connecting:** Check the wiring in the vehicle carefully. Incorrect connection may cause serious damage to this unit. The leads of the power cord and those of the connector from the car body may be different in color.

- 1 Connect the colored leads of the power cord in the order specified in the illustration below.
- 2 Connect the antenna cord.
- 3 Finally connect the wiring harness to the unit.

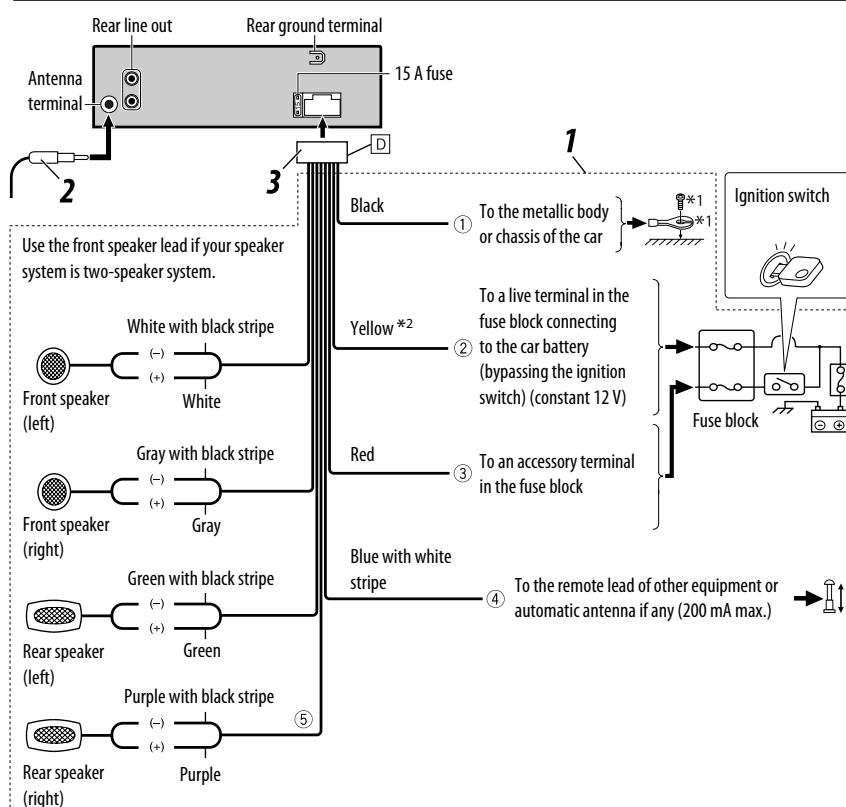

### Connecting the external amplifier or subwoofer

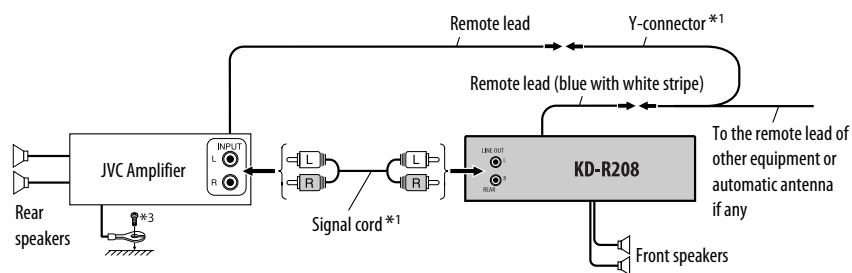

- \*1 Not supplied for this unit.
- \*2 Before checking the operation of this unit prior to installation, this lead must be connected, otherwise the power cannot be turned on.
- \*3 Firmly attach the ground wire to the metallic body or to the chassis of the car—to the place uncoated with paint (if coated with paint, remove the paint before attaching the wire). Failure to do so may cause damage to the unit.

### PRECAUTIONS on power supply and speaker connections

